

# CE (410) Series

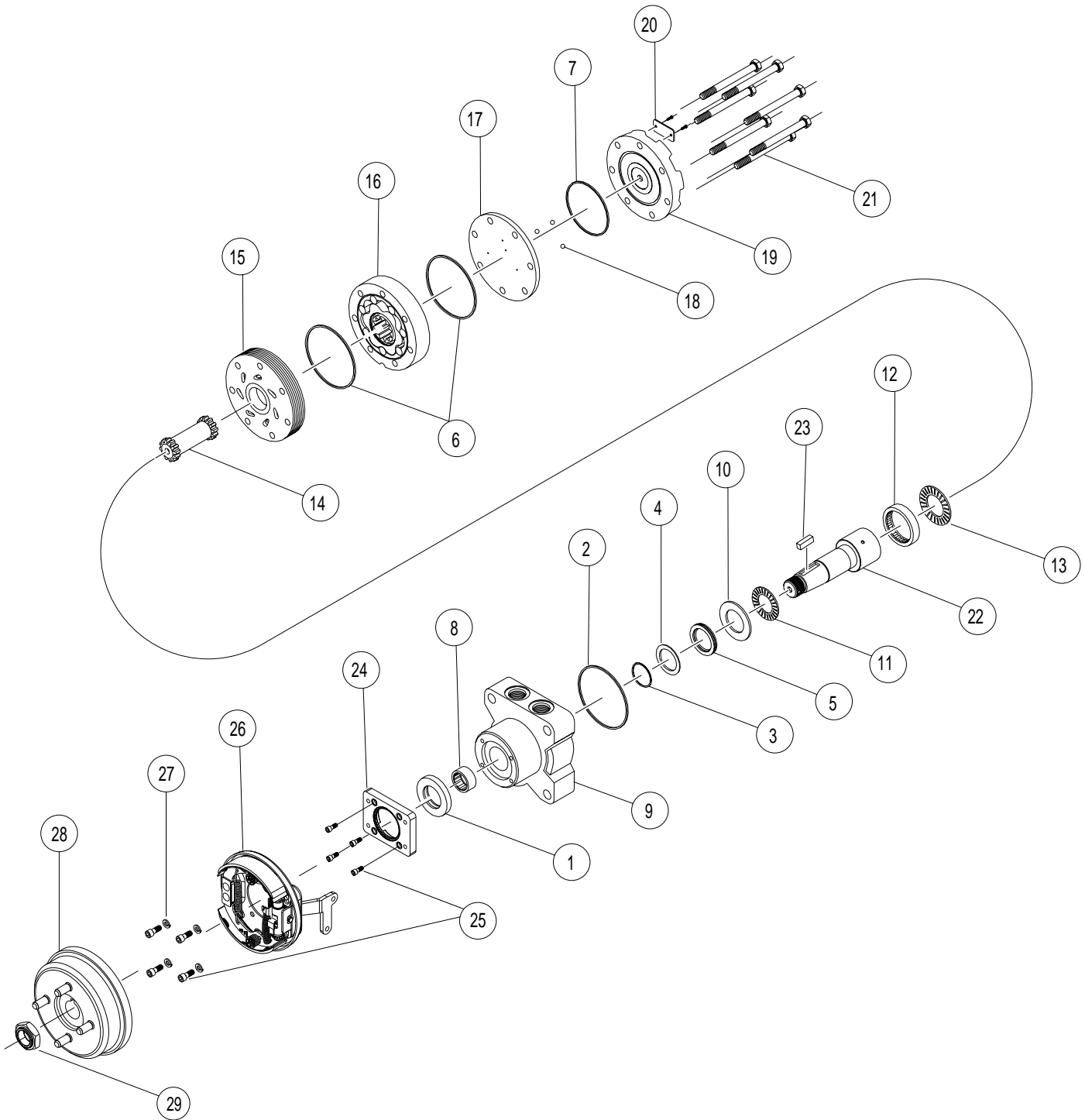

# CE (410) SERIES MOTOR BRAKE COMPONENTS

## SEAL KIT 400444300

DESCRIPTION	EXP. VIEW ITEM #	KIT
DUST SEAL	1	
REAR HOUSING SEAL	2	ITEMS # 1-7
METAL SHIM	3	INCLUDED IN
BACK-UP SEAL	4	SEAL KIT
SHAFT SEAL	5	400444300
BODY SEALS (2)	6	
ENDCOVER SEAL	7	
REAR HOUSING BEARING	12	ITEMS # 1-7 & 12
		INCLUDED IN
		SEAL KIT
		400444300E
NOTE: REAR BEARING (#12) MUST BE REMOVED TO REPLACE SEAL KIT ITEMS #3-5. OR FRONT THRUST BEARING AND WASHERS (#10-11). IT IS RECOMMENDED THAT A NEW REAR BEARING BE INSTALLED WHEN ASSEMBLING.		

## MISCELLANEOUS KITS

DESCRIPTION	EXP. VIEW ITEM #	KIT
FRONT HOUSING BEARING	8	400018006
FRONT THRUST WASHER	10	500018253
FRONT THRUST BEARING	11	500018252
REAR HOUSING BEARING	12	500018002
REAR THRUST BEARING	13	500018059
FORWARD MANIFOLD (CCW O R"0")	15	500015006
REVERSE MANIFOLD (CW OR "1")	15	500015007
BALANCE PLATE	17	500012001
STEEL BALLS (3)	18	500018048
ENDCOVER	19	500016001
BRAKE MOUNTING BLOCK	24	400180048
MOUNTING BOLTS (4)	25	400180050
BRAKE KIT (LEFT HAND LEVER)	NOT SHOWN	400180047
BRAKE KIT (RIGHT HAND LEVER)	26	400180046
LOCK WASHERS	27	400180045
4 BOLT BRAKE HUB	28	400180008
5 BOLT BRAKE HUB	NOT SHOWN	400180500

## ROTORS, DRIVE LINKS AND SPACERS, AND BOLTS

WHEN CHANGING MOTOR DISPLACEMENTS, A MATCHING ROTOR AND BOLT SET KIT MUST BE ORDERED. A NEW DRIVE LINK KIT MAY BE NECESSARY.

EXPLODED VIEW ITEM #	16	16	14	21
DISPLACEMENT	STANDARD ROTOR KIT	FREETURN ROTOR KIT	DRIVE LINK KIT	BOLT SET KIT
120	500087005	500087008	400140007	500445006
160	500137005	500137011	400140007	500445006
200	500167004	500167011	400140012	500445012
230	500147002	500147004	400140014	500445014
260	500227000	500227004	400140016	500445014
300	500247005	500247011	400140018	500445018
350	500207000	500207004	400140020	500445026
375	500307005	500307011	400140024	500445024
470	500357003	500357005	400140020	500445026
540	500407005	500407011	400140032	500445032
750	500607005	500607011	400140045	500445045

## HOUSING KITS

HOUSING KITS INCLUDE THE FRONT BEARING (#8), METAL SHIM (#3), POLYAMIDE BACK-UP SEAL(#4), AND SHAFT SEAL (#5) INSTALLED IN THE HOUSING.

DESCRIPTION	EXPLODED VIEW ITEM #	HOUSING KIT
#K31- SETBACK FLANGE W/BRAKE MOUNT (7/8-14 O-RING PORTS)	9	400130041
#K38- SETBACK FLANGE W/BRAKE MOUNT (1/2-14 BSP.F PORTS)	9	400130042
#K35- SETBACK FLANGE W/BRAKE MOUNT (9/16-18 PORTS)	9	400130043

## SHAFTS AND RELATED COMPONENTS KITS

SHAFT KITS COME WITH RELATED SHAFT COMPONENTS (i.e. keys, nuts, etc.)

TO ORDER INDIVIDUAL SHAFT COMPONENTS (i.e. keys, nuts, bolts, washers or wire rings) USE THE KIT NUMBER FOR EACH INDIVIDUAL PART.

EXPLODED VIEW ITEM #	22	23	29
DESCRIPTION	SHAFT KIT	KEY KIT	NUT KIT
#22- 1-1/4" TAPERED	400110043	500449106	300339303P